



Meaningful Innovation.

**Instruction Manual
Battery Storage**

VT-12040

**LiFePO4
Household Energy
Storage Series
User Instruction Manual
V1.1**

Date: 20/03/2024



Preface

Thank you for selecting and purchasing V-TAC product. V-TAC will provide you the best service. Please read this instruction carefully & keep this user manual handy for future reference. If you have any another query, please contact our dealer or local vendor from whom you have purchased the product.

In case of any query / issue with the product ,please contact us at :support@v-tac.eu , For more products range and inquiry ,please contact our distributors or nearest dealers V-TAC EUROPE LTD, Bulgaria ,Plovdiv 4000, Bul.I.Karavelow 9B

This document mainly introduces the product introduction,application scenario, installation,commissioning,system maintenance and technical data of household energy storage battery .





Reader object:

This document is mainly applicable to the following Engineers:

- ◆ Marketing Engineer
- ◆ System Engineer
- ◆ Technical support engineer

Symbolic Covention:

The following symbols may appear in this article, and they represent the following meanings:

Symbol	Explanation
 DANGER	Indicates a hazard with high risk that will lead to death or serious injury if not avoided.
 Warning	Indicates a hazard with medium risk that may lead to death or serious injury if not avoided.
 Attention	Indicates a hazard with low-level risk that may cause slight or moderate injury if not avoided.
 Notice	It is used to transmit equipment or environmental safety warning information. If not avoided, it may lead to equipment damage, data loss, equipment performance degradation or other unpredictable results. The "instructions" do not involve personal injury.
 Explanation	Indicates a hazard with high risk that will lead to death or serious injury if not avoided.

Warning:

- 1.Please make sure to turn off the power before starting the installation.
- 2.Installation must be performed by a qualified electrician.



This marking indicates that this product should not be disposed of with other household wastes.

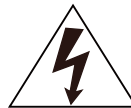

Caution, risk of electric shock.

Content

1.Safety precautions	
1.1 General security.....	1-3
1.2 Personnel requirements.....	4
1.3 Electrical safety.....	4-5
2.Product introduction	
2.1 Product function and technical specification.....	5-6
2.2 Appearance description.....	7
2.3 System diagram.....	8
2.4 System sleep and wake up.....	9
3.Product installation	
3.1 Unpacking inspection.....	9
3.2 Basic installation requirements.....	10
3.3 Safety of handing heavy objects.....	10
4.System connection	
4.1 Communication line	11-12
4.2 System connection diagram	13
4.3 Battery connection.....	13-16
5.System tuning	
5.1 Check before power on	16-18
5.2 Buzzer action description	18
5.3 RST key description	18-19
5.4 Indication description	19
5.5 Sleep and wake up	19-20
5.6 Wireless kits(optional)	20-22
6.Battery monitoring	
6.1 Software running enviroment	23
6.2 Connect the upper computer	23-24
6.3 Interface function	24-28
6.4 Replacing inverter protocol(optional)	29
7.Maintaince and replacemment.....	30
8.Battery storage requirement.....	30
9.Compatible List of 7.6KWh POWER ESS and Inverters.....	31

1. Safety precautions

1.1 General security

Statement

When installing, operating and maintaining the equipment, please read this manual first and follow the signs on the equipment and all safety precautions .

The "notice", "attention", "warning" and "danger" in the manual do not represent all safety precautions to be observed, but only supplement all safety precautions. The company shall not be liable for any violation of general safety operation requirements or safety standards for design, production and use of equipment.

The equipment shall be used in an environment that meets the requirements of design specifications, otherwise it may cause equipment failure, and the resulting equipment function abnormalities or component damage, personal safety accidents, property losses, etc. are not within the scope of equipment quality assurance. The installation, operation and maintenance of the equipment shall comply with local laws, regulations and specifications. The safety precautions in the manual are only a supplement to local laws, regulations and specifications.

The company shall not be liable for any of the following circumstances.

- ◆ Do not operate under the service conditions described in this manual.
- ◆ The installation and use environment exceeds the provisions of relevant international or national standards.
- ◆ Disassemble, change the product or modify the software code without authorization.
- ◆ Failure to follow the operation instructions and safety warnings in the product and documents.
- ◆ Transportation damage caused by customer's own transportation.
- ◆ Damage caused by storage conditions not meeting the requirements of product documents.

General requirements



Live operation is strictly prohibited during installation.

- ◆ It is strictly prohibited to install, use and operate outdoor equipment and cables (including but not limited to handling equipment, operating equipment and cables, plug and unplug signal interfaces connected to outdoor, high-altitude operation, outdoor installation, etc.) in severe weather such as lightning, rain, snow and force gale.
- ◆ After installing the equipment, the empty packaging materials such as cartons, foam, plastic, tie line should be removed.
- ◆ In case of fire, evacuate the building or equipment area and press the fire alarm bell or dial the fire alarm telephone. Under no circumstances shall re-enter the burning building.
- ◆ It is strictly prohibited to artificially alter, damage or block the identification and nameplate on the equipment.

- ◆ When installing the equipment, use tools to tighten the screws.
- ◆ Paint scratches during equipment transportation and installation must be repaired in time. It is strictly prohibited to expose the scratched parts to the outdoor environment for a long time.
- ◆ Do not open the main panel of the device without the permission of the manufacturer.
- ◆ In any case, do not change the structure and installation sequence of the equipment without the permission of the manufacturer.
- ◆ It is forbidden to affect the battery terminal components during handling, and it is not allowed to lift and handle through the battery terminal bolts.
- ◆ It is not allowed to reverse engineer, decompile, disassemble, adapt, implant or other derivative operations on the equipment software, and it is not allowed to study the internal implementation of the equipment in any way.

Personal safety

- ◆ Wear appropriate personal protective equipment during equipment operation. In case of any fault that may cause personal injury or equipment damage, the operation shall be terminated immediately, the person in charge shall be reported, and effective protective measures shall be taken.
- ◆ Before using the tool, please master the correct use method of the tool to avoid personal injury and equipment damage.
- ◆ When the equipment is running, the shell temperature is high and there is a risk of burns. Do not touch it.
- ◆ In case of battery failure, the temperature may exceed the burn threshold of the touchable surface, and contact should be avoided.
- ◆ Do not open or damage the battery. The released electrolyte is harmful to the skin and eyes. Avoid contact.
- ◆ Do not place irrelevant items on the top of the equipment or insert them anywhere in the equipment.
- ◆ Do not place inflammables around the equipment.
- ◆ The battery shall not be placed in the fire to avoid explosion and endanger personal safety.
- ◆ Do not place the battery module in water or other liquids.
- ◆ Do not short-circuit the battery terminal, which may cause combustion.
- ◆ The battery may cause the danger of electric shock and large short-circuit current. When using the battery, pay attention to the following precautions :
 - a) Remove watches, rings or other metal objects.
 - b) Tools using insulated handles .
 - c) Wear rubber gloves and boots .
 - d) Do not place tools or metal parts on the top of the battery .
 - e) Disconnect the charging power supply before connecting or disconnecting the battery terminal.
- ◆ Do not use water or detergent to clean the electrical parts inside and outside the cabinet.

- ◆ Do not stand or lean on or sit on the equipment.
- ◆ Do not damage each module of the equipment.
- ◆ When installing the battery module, if the battery module falls or is strongly impacted, the equipment will be damaged. It is strictly prohibited to continue to use, otherwise there will be safety risks (cell leakage, electric shock injury, etc.).

Treatment measures for battery leakage

In case of electrolyte leakage, avoid contact with leaked liquid or gas. Electrolyte is corrosive and contact may cause skin irritation and chemical burns. In case of contact with battery electrolyte, the following measures shall be taken.

Inhalation: evacuate the contaminated area, enter fresh air immediately, and seek medical help immediately.

Eye contact: immediately flush eyes with plenty of water for at least 15 minutes, do not rub, and seek medical help immediately.

Skin contact: immediately wash the contact area with plenty of water and soap and seek medical help immediately.

Ingestion: seek medical help immediately.

Fire treatment measures

- ◆ In case of fire, the system should be powered off under the condition of ensuring safety.
- ◆ Use carbon dioxide, FM-200 or ABC dry powder fire extinguisher to extinguish the fire.



When the battery temperature is too high, it will cause battery deformation, damage, electrolyte overflow and toxic gas leakage. Please keep away from it to avoid skin irritation and chemical burns.

Flood emergency measures

- ◆ Power down the system to ensure personal safety.
- ◆ If any part of the battery is flooded, do not touch the battery to avoid electric shock.
- ◆ Do not use the flooded battery. Contact the battery recycling company for scrapping.

Battery recycling

- ◆ Please dispose of waste batteries according to local laws and regulations. Do not treat batteries as domestic waste.
- ◆ If the battery leaks or bulges, please contact technical support or battery recycling company for scrapping.
- ◆ When the battery is unavailable beyond its service life, please contact the battery recycling company for scrapping.
- ◆ Avoid exposing the battery to high temperature or direct sunlight.
- ◆ Avoid exposing the battery to high humidity or corrosive environment.

1.2 Personnel requirements

- ◆ The personnel responsible for the installation and maintenance of this equipment must understand various safety precautions and master the correct operation methods.
- ◆ Only qualified professionals or trained personnel are allowed to install, operate and maintain the equipment.
- ◆ Only qualified professionals are allowed to dismantle safety facilities and overhaul equipment.
- ◆ Personnel operating the equipment, including operators, trained personnel and professionals, shall have the special operation qualification required by the local state.
- ◆ The replacement of equipment or components (including software) must be completed by professionals or authorized personnel.



Explanation

- ◆ Professionals: those who have training or experience in operating equipment and can understand the potential sources and magnitude of hazards in the process of equipment installation, operation and maintenance.
- ◆ Trained personnel: personnel who have received corresponding technical training and have necessary experience, can be aware of the risks that may be brought to him during a certain operation, and can take measures to minimize the risks to himself or other personnel.
- ◆ Operators: operators who may come into contact with the equipment other than trained personnel and professionals.

1.3 Electrical safety

General requirements



DANGER

Before making electrical connection, please ensure that the equipment is not damaged, otherwise electric shock or fire may be caused.

- ◆ All electrical connections must meet the national electrical standards.
- ◆ The cable provided by the user shall meet the requirements of local laws and regulations.
- ◆ Use special insulating tools for high voltage operation.

DC operation



DANGER

It is forbidden to install or remove the power line with electricity. When the power cord contacts the conductor, it will produce arc or electric spark, which can lead to fire or personal injury.

- ◆ Before the electrical connection of the equipment, if the live parts may be touched, the corresponding breaking device at the front level of the equipment must be disconnected.
- ◆ Before connecting the power cord, confirm that the label identification of the power cord is correct before connecting.

- ◆ If the equipment has multiple inputs, all inputs of the equipment shall be disconnected, and the equipment can be operated only after the equipment is completely powered off.

Wiring requirements

- ◆ The use of the cable in high temperature environment may cause aging and damage of the insulating layer. The distance between the cable and the periphery of the heating device or heat source area shall be at least 30mm.
- ◆ Similar cables shall be bound together, and different types of cables shall be laid at least 30mm apart. Mutual winding or cross laying is prohibited.
- ◆ The cables used must be firmly connected, well insulated and of appropriate specifications.

2.Product introduction

2.1 Product introduction

Function

Li-ion battery includes only battery modules, which can store and release electric energy according to the requirements of inverter management system. The input and output ports of battery are 48 / 51.2V DC.

- ◆ Battery charging: the power control module is connected with the energy storage terminals (BAT +, bat -) of the inverter to charge the battery and store the excess photovoltaic energy in the battery under the control of the inverter.
- ◆ Battery discharge: when the photovoltaic energy is insufficient to supply power to the load, the system needs to control the battery to supply power to the load and output the stored battery energy to the load through the inverter.

Technical specification

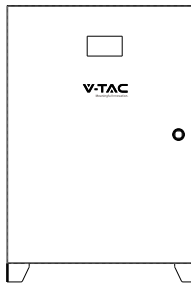

VT-12040

ID	Voltage	Capacity	IP Level	Screen
VT-12040	48V/51.2V	200Ah	IP21	HMI

VT-12040 technical specification

Battery type	LFP
Rated capacity of battery pack	200Ah
Rated voltage of battery pack	51.2V
Maximum charging voltage	57.6V
Minimum discharge voltage	40V
Rated charge/discharge current	100A
Maximum charge/discharge current	100A
Charging temperature range	0 to +45°C
Discharge temperature range	-20°C to +50°C
Depth of discharge	> 80%
Discharge magnification	< 1C
Self-discharge (25°C)	< 3%/Month
Cycle life	> 5000 times (< 0.5C)
Interactive mode	HMI
Dimension	750*515*250mm (±2mm)
Weight	93.0KG
Compatible with Solar Inverter Deye, Solis, Sofar, Afore, Growatt, etc	

2.2 Appearance description

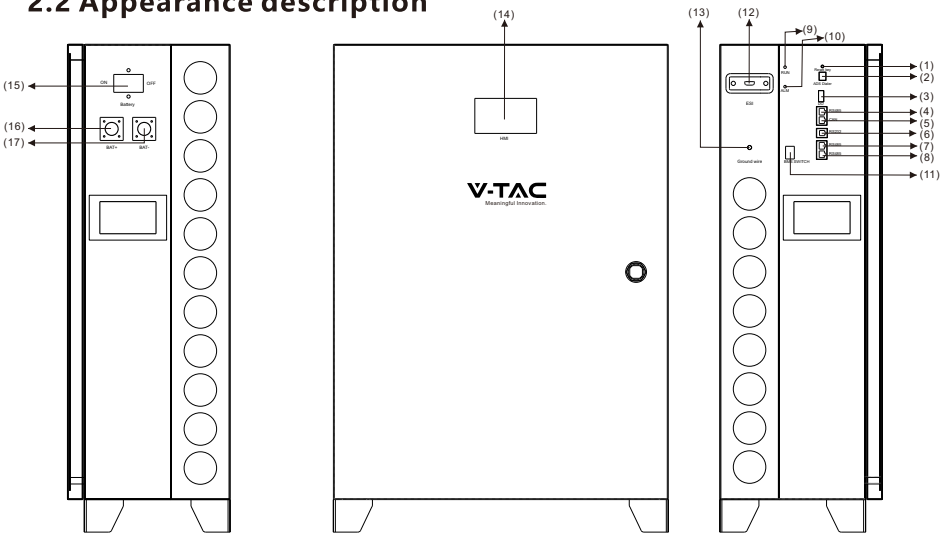

No.	Description	Functional Description
1	Reset key	Reset
2	ADS Dialer	Display connection address
3	DO	1/2 Normally open, closed during fault protection 3/4 Normally open, closed when a low battery alarm signal has occurred
4	RS485	RS485 communication interface
5	CAN	CAN communication interface
6	RS232	RS232 communication interface (for battery condition monitoring)
7	RS485	RS485 communication interface (Used in communication parallel, and for battery condition monitoring or manufacturer to debug or service)
8	RS485	RS485 communication interface (Used in communication parallel, and for battery condition monitoring or manufacturer to debug or service)
9	RUN	Work
10	ALM	Alarm and protection
11	BMS switch	ON / OFF switch
12	ESI	Expand Bluetooth / WiFi / GSM functions
13	Ground wire	Battery ground wire
14	HMI	Display battery status information
15	Battery	Out put ON/OFF
16	Battery+	Positive terminal
17	Battery-	Negetive terminal

2.3 System diagram

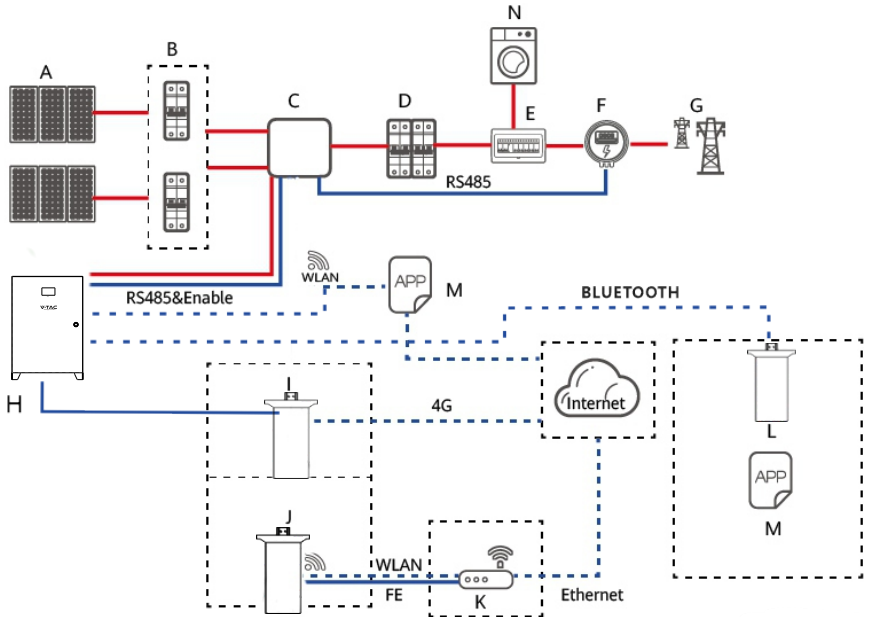

(A) PV module

(B) DC switch

(C) Inverter

(D) AC switch

(E) Power Distribution Box

(F) Intelligent power collector

(G) Power grid

(H) Battery(WALL)

(I) GSM

(J) WIFI

(K) Router

(L) Bluetooth

(M) APP

(N) Load

Explanation

- ◆ The input and output of the battery energy storage system are connected to the energy storage port of the inverter.
- ◆ Following are the modes to communicate with the battery energy storage system:
 - The Inverter can be connected through CAN interface to realize the communication and control between the inverter and battery.
 - The battery can be accessed directly through the mobile phone Bluetooth app to view, manage and maintain the performance.
 - The battery can be accessed from the public network through WiFi interface to view, manage and maintain the performance.
 - The battery can be accessed from the public network through GSM interface to view, manage and maintain the performance.

2.4 System sleep and wake Up

Sleep:

When any of the following conditions is met, the system enters the low power consumption mode:

- ◆ Press the BMS switch button to "O"(off).
- ◆ The minimum monomer voltage is lower than the sleep voltage, and the duration reaches the sleep delay time (no communication, no protection, no balance and no current).

Notice

Before entering sleep, ensure that the input terminal is not connected to the external voltage, otherwise it will not be able to enter the low power consumption mode.

Wake up:

When the system is in the low power consumption mode and meets any of the following conditions, the system will exit the low power consumption mode and enter the normal operation mode:

- ◆ Connect the charger, and the output voltage of the charger shall be greater than 48V.
- ◆ Press the BMS switch button to "I"(on).

3.Product installation

3.1 Unpacking inspection

Please confirm whether the outer package of the product is damaged before unpacking. After unpacking, please carefully check the product for damage or lack of accessories. In case of damage or lack of accessories, please contact the supplier directly for assistance.

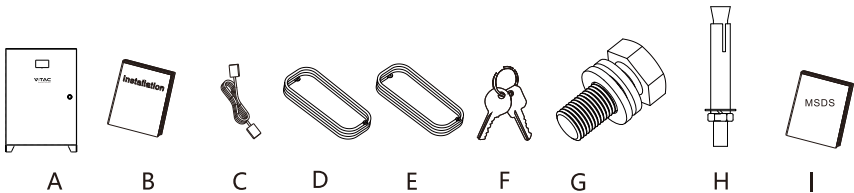

No.	Q'ty	Description
A	1	Battery pack
B	1	Instruction manual
C	1	BMS to inverter communication line,L=1.5 meter
D	1	20mm ² M8 to M8 power cord (Red color for positive pole, L=1.5 meter)
E	1	20mm ² M8 to M8 power cord (Black color for negative pole, L=1.5 meter)
F	1	Battery pack case door key
G	2	M8X16 screw to fix power cord (BMS side)
H	4	M10X100 expansion screw
I	1	MSDS transportation certificate

3.2 Basic installation requirements

- ◆ It shall be installed in a dry and well ventilated environment to ensure good heat dissipation.
- ◆ It is recommended to choose a sheltered installation site or build a sunshade.
- ◆ Avoid direct sunlight or rain, the surrounding environment is clean, and there is no large amount of infrared radiation, organic solvents and corrosive gases. It is preferred to be indoors.



- ◆ The installation position shall be away from the fire source.
- ◆ The installation position is not accessible to children.
- ◆ The installation position shall be far away from water sources, such as faucets, sewer pipes, sprinklers, etc., to avoid water infiltration.
- ◆ The installation wall can support the weight of the battery for a long time.
- ◆ Make sure that the selected installation location matches the size of the battery.
- ◆ Do not place inflammables and explosives around the battery.
- ◆ When the battery is running, do not block the vent or cooling system to prevent high temperature fire. Battery operating temperature, charging 0-55°C, discharging - 20 ~ 60 °C.
- ◆ It is forbidden to put the battery in the environment of flammable, explosive gas or smoke, and any operation in this environment is prohibited.

3.3 Safety of handling heavy objects

- ◆ When carrying heavy objects, be prepared to bear the load to avoid being crushed or sprained by the heavy objects.

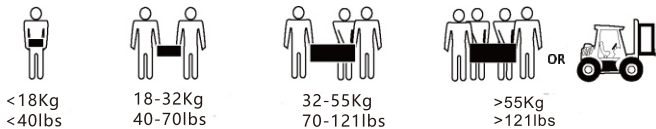

- ◆ When handling the equipment by hand, wear protective gloves to avoid injury.

4.1 Communication line

RJ45 Communication point definition(8P8C)



PIN	RS485	CAN
1	RS485_B	NC
2	RS485_A	NC
3	GND	NC
4	NC	CANH
5	NC	CANL
6	GND	NC
7	RS485_A	GND
8	RS485_B	NC

RJ11 Communication point definition(6P6C)



PIN	Rs232
1	NC
2	NC
3	TX
4	RX
5	GND
6	NC

Explanation

- ◆ RS232 communication: BMS can communicate with the computer through RS232 interface to check battery health related information including battery voltage, current, temperature, and manufacturer's default data.
- ◆ RS485 / CAN communication: CAN communication connects the battery with the inverter to function as duo for operations.
- ◆ RS485 communication: The additional two RS485 interfaces can be used for parallel connections with other batteries, or, to monitor battery health conditions including debugging and routine servicing.
Addresses PIN: 1-15

Explanation

RS485 Communication point definition

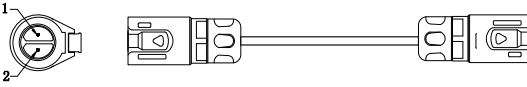

PIN	RS485
1	RS485_B
2	RS485_A

RS232 Communication point definition



PIN	RS232
1	RX
2	TX
3	GND

CAN Communication point definition

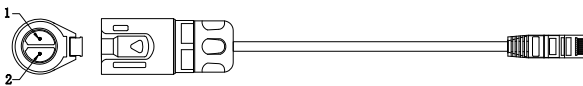

PIN	CAN	8P8C
1	CANL	12_CANL
2	CANH	13_CANH

4.2 System connection diagram

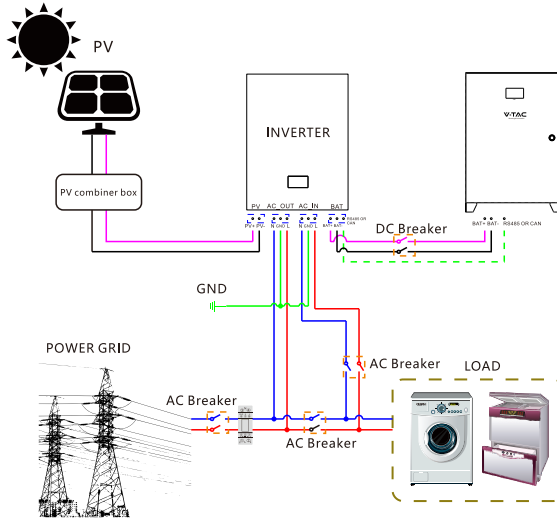

Cable color	Description	Cable color	Description
	DC positive wire		Live Wire
	DC negative wire		Naught wire
	Ground wire		Communication line

- ◆ Different inverter communication protocols have different pin definitions. Please pay attention to the compatibility between the battery and inverter RS485 / can communication line.

4.3 Battery connection

Single battery connection

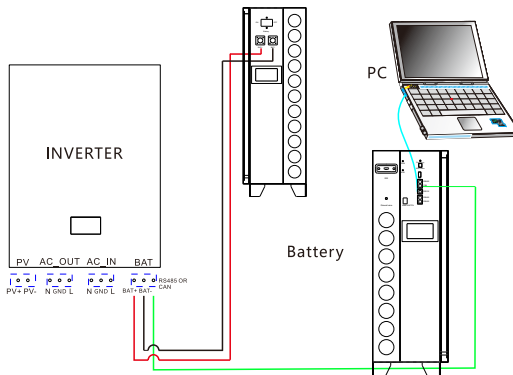

Cable color	Description	Cable color	Description
	DC positive wire		RJ45 Communication Line RS485/CAN communication
	DC negative wire		RJ11 Communication Line

Multiple batteries in parallel

When the maximum continuous output power of the inverter is less than 6kW, the connection mode is as follows:

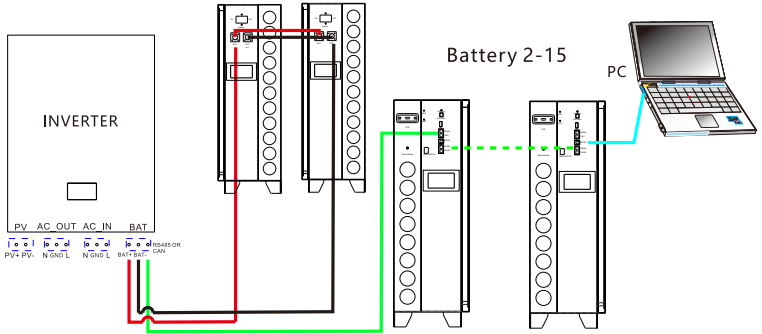

Cable color	Description	Cable color	Description
	DC positive wire		RJ11 Communication Line
	DC negative wire		Parallel Communication line
	RJ45 Communication Line RS485/CAN communication		

When the maximum continuous output power of the inverter is greater than 6kW, the connection mode is as follows:

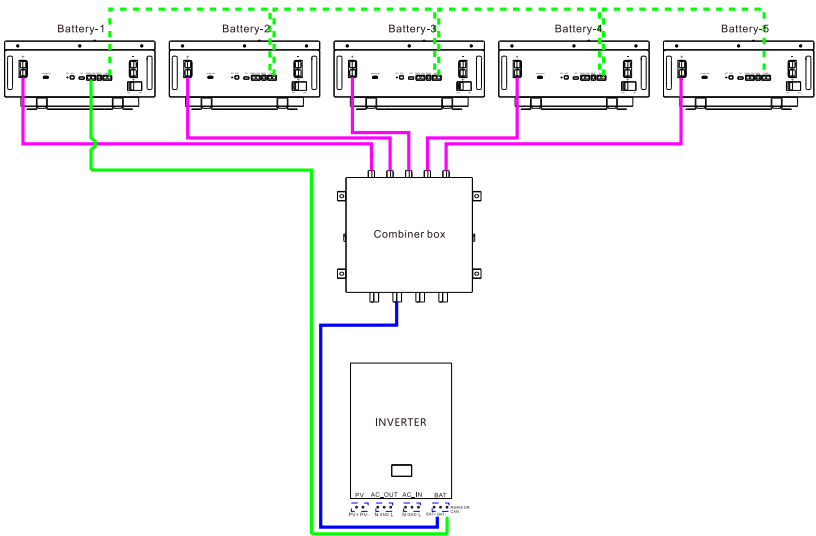

Multiple Inverters:

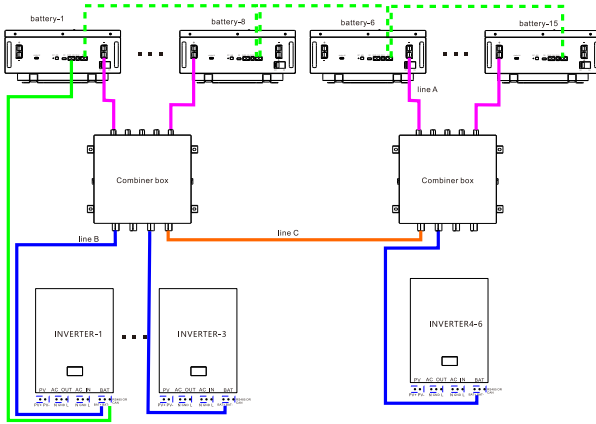

Cable color	Description	Cable color	Description
	Line A, battery to combiner box		Parallel Communication line
	Line B, inverter to combiner box		RJ45 Communication Line RS485/CAN communication
	Line C, Power line, combiner box parallel		

Explanation

- ◆ The maximum number of batteries can only be connected in parallel is 15pcs. After parallel connection, the address of ads needs to be assigned, as shown below:

Address	Dial switch					Remark
	#1	#2	#3	#4		
0	OFF	OFF	OFF	OFF		
1	ON	OFF	OFF	OFF		Battery PACK1(Main PACK)
2	OFF	ON	OFF	OFF		Battery PACK2
3	ON	ON	OFF	OFF		Battery PACK3
4	OFF	OFF	ON	OFF		Battery PACK4
5	ON	OFF	ON	OFF		Battery PACK5
6	OFF	ON	ON	OFF		Battery PACK6
7	ON	ON	ON	OFF		Battery PACK7
8	OFF	OFF	OFF	ON		Battery PACK8
9	ON	OFF	OFF	ON		Battery PACK9
10	OFF	ON	OFF	ON		Battery PACK10
11	ON	ON	OFF	ON		Battery PACK11
12	OFF	OFF	ON	ON		Battery PACK12
13	ON	OFF	ON	ON		Battery PACK13
14	OFF	ON	ON	ON		Battery PACK14
15	ON	ON	ON	ON		Battery PACK15

- ◆ The inverter only needs to communicate with the host (Pack1).
- ◆ When multiple batteries are connected with multiple inverters, it is best to connect through the combiner box. If it is not connected through the combiner box, the wiring mode shall be confirmed with the manufacturer's agent. And the cable from each battery to the inverter remains the same length.

Notice

- ◆ Batteries are not allowed to be connected in series.
- ◆ Different batteries with different chemistries, different batches of batteries from the same chemistry and technical design parameters can not be bundled and used together.

5. System tuning

5.1 Check before power on





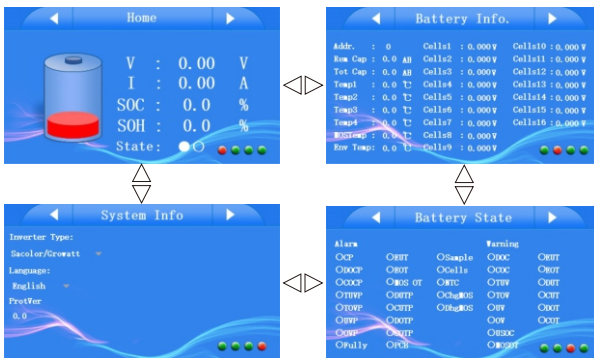

NO.	Inspection items	Acceptance criteria
1	The energy storage battery is installed in place	The installation is correct, firm and reliable.
2	Reasonable cable layout	The cable layout is reasonable to meet the user's requirements.
3	Beautiful binding of cable ties	The cable ties shall be uniform and no sharp corners shall be left at the cut.
4	Reliable grounding	The ground wire is connected correctly, firmly and reliably.
5	Disconnect switch	"DC switch" and all switches connected to energy storage are in "off" state.
6	The cable is connected in place	The DC input line, energy storage line and signal line are connected correctly, firmly and reliably.
7	Insulate unused terminals and interfaces	Install insulating tape on unused terminals and interfaces.
8	The installation environment meets the requirements	The installation space is reasonable, the environment is clean and tidy, and there is no construction residue.

After the inspection, press and hold the RST key (3 ~ 6S) and release it, the protection board is activated.

HMI screen composition



Home:

NO.	ICON	Description
1		0% < SOC < 25%
2		25% = SOC < 50%
3		50% = SOC < 75%
4		75% = SOC = 100%
5		SOC = 0%
6		Battery Alarm Status

Battery Information:

NO.	Items	Description	NO.	Items	Description
1	Addr.	Battery Pack Address	5	Env Temp	Environment temperature
2	Rem Cap	Remnant capacity	6	MOS Temp	MOS Temperature
3	Tol Cap	Total capacity	7	Cells1~16	Battery Cell Voltage
4	Temp1~4	Battery Temperature			

Battery Information: Protection Status

NO.	Items	Description	NO.	Items	Description
1	CP	Short Circuit Protection	12	DUTP	Discharge low temperature protection
2	DOCP	Discharge over current protection	13	CUTP	Charge low temperature protection
3	COCP	Charge over current protection	14	DOTP	Discharge high temperature protection
4	TUVP	Total under voltage protection	15	COTP	Charge high temperature protection
5	TOVP	Total over voltage protection	16	PCB	PCB Protection
6	UVP	Cell over discharge protection	17	Sample	Sample Protection
7	OVP	Cell over voltage protection	18	Cells	Battery Cells Protection
8	Fully	Fully protection	19	NTC	NTC Protection
9	EUT	Low environment temperature protection	20	chg MOS	Charge MOS protection
10	EOT	High environment temperature protection	21	dhg MOS	Discharge MOS protection
11	MOS OT	MOS High temperature protection			

Battery Information: Alarm Status

NO.	Items	Description	NO.	Items	Description
1	DOC	Discharge over current alarm	8	MOS OT	MOS High temperature alarm
2	COC	Charge over current alarm	9	EUT	Low environment temperature alarm
3	TUV	Total over discharge alarm	10	EOT	High environment temperature alarm
4	TOV	Total over charge alarm	11	DUT	Discharge low temperature alarm
5	UV	Cell over discharge alarm	12	CUT	Charge low temperature alarm
6	OV	Cell over discharge alarm	13	DOT	Discharge high temperature alarm
7	USOC	Low SOC alarm	14	COT	Charge high temperature alarm

Explanation

- ◆ Battery is in protection state: ●
- ◆ Battery is in normal state: ○
- ◆ Battery is in alarm: ●

System Information Interface

NO.	Items	Description
1	Inverter	Support 10 kind of inverters , we will still upgrade.
2	Language Setting	3 Languages for setting

5.2 Buzzer action description

NO.	Mode	Description
1	Fault	Beep 0.25S every 1S
2	Protection	Beep 0.25S every 2S (except over voltage protection)
3	Alarm	Beep 0.25S every 3S (except over voltage alarm)

Explanation

The buzzer function can be enabled or disabled by the upper computer. It is disabled by default.

5.3 RST key description



NO.	Mode	Description
1	Fault	BMS is in sleep state, press the BMS swith button to "I" (on), the protection board is activated, and the LED indicator lights up successively from "run" for 0.5 seconds.
2	Dormancy	BMS is in the active state ,press the BMS switch button to "O" (off) , the protection board is dormant.
3	Reset	BMS is active ,press the reset key (6 ~ 10s) and release it, the protection board is reset, and all LED lights are on for 1.5 seconds at the same time.

Explanation

After the BMS is reset, it still retains the parameters and functions set by the upper computer. If it needs to be restored to the initial parameters, it can be realized through the "restore default value" of the upper computer, but the relevant operation records and stored data remain unchanged (such as power, cycle times, protection records, etc.).

5.4 Indication description

HMI Screen: There are 2LEDS on front panel to show the battery working status.

PACK Status	Normal/Alarm/Protection	RUN	ALM	Remark
				
Power Off	Sleep	OFF	OFF	All off
Standby	Normal	Flash 1	OFF	Standby state
	Alarm	Flash 1	Flash 3	Cell low voltage
Charge	Normal	ON	OFF	The maximum power LED flashes (flashes 2), and the overcharge alarm ALM does not flash
	Alarm	ON	Flash 3	
	Over Charge protection	ON	OFF	If there is no mains power, LED as standby
	Temperature/Over current Fault/Protection	OFF	ON	Close charge
Discharge	Normal	Flash 3	OFF	
	Alarm	Flash 3	Flash 3	
	Under Discharge Protection	OFF	OFF	Close discharge
	Temperature/Over current Short circuit/Fault/Protection	OFF	ON	
Fault		OFF	ON	Close charge/discharge

5.5 Sleep and wake up

Sleep:

When any of the following conditions is met, the system enters the low power consumption mode:

- ◆ Single or overall over discharge protection is not released within 30 seconds.
- ◆ Press the BMS switch button to "O" (off)
- ◆ The minimum monomer voltage is lower than the sleep voltage, and the duration reaches the sleep delay time (no communication, no protection, no balance and no current).
- ◆ The standby time exceeds 24 hours (no communication, no charge and discharge, no mains power).
- ◆ Forced shutdown by upper computer software.

Notice

Before entering sleep, ensure that the input terminal is not connected to the external voltage, otherwise it will not be able to enter the low power consumption mode.

Notice

Before entering sleep, ensure that the input terminal is not connected to the external voltage, otherwise it will not be able to enter the low power consumption mode.

Wake up:

When the system is in the low power consumption mode and meets any of the following conditions, the system will exit the low power consumption mode and enter the normal operation mode:

- ◆ Connect the charger, and the output voltage of the charger shall be greater than 48V. (the battery voltage of 16 strings needs to be greater than 51.2V)
- ◆ Press the BMS switch button to "1" (on)
- ◆ With RS232 activation.

Notice

After single or overall over discharge protection, enter the low power consumption mode, wake up regularly every 4 hours, and turn on the charge discharge MOS. If it can be charged, it will exit the sleep state and enter normal charging; If the Automatic wake-up fails to charge for 10 consecutive times, it will no longer wake up automatically.

When the system is defined as that the recovery voltage is not reached after 2 days of standby (standby time setting value) after the end of charging, it is forced to resume charging until the end of recharging.

5.6 Wireless kit (Optional)

The wireless kit is divided into three modules:

- ◆ Bluetooth
- ◆ WIFI
- ◆ GSM

Each module is an independent module, which module can be confirmed by label.

Outline drawing of wireless Kit

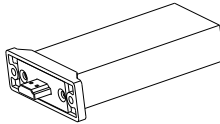

connect using:

- ◆ Insert the module into the battery wireless kit port, download the wireless kit app, and register the account after installation.
- ◆ After turning on Bluetooth / WiFi / GSM, click Add device.

Explanation

- ◆ The maximum connection range of Bluetooth is only 12 meters.
- ◆ GSM needs to plug in the corresponding SIM card and can use network services. The installation method of SIM card is shown in the figure below:

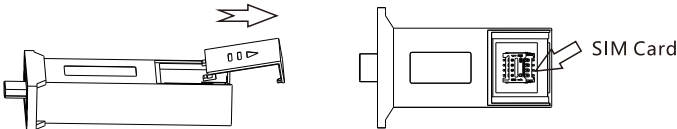

App interface description and operation steps

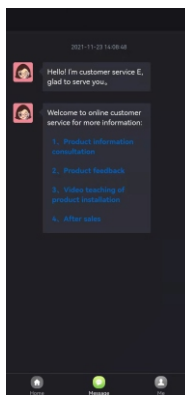
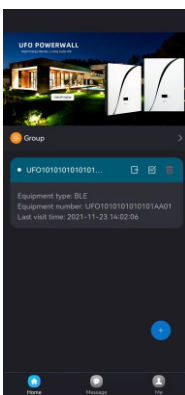
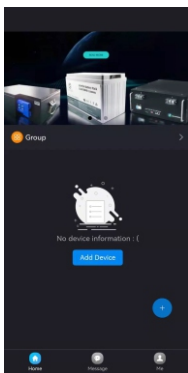
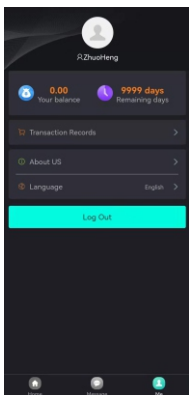

User registration

Switch to "ME" in the lower right corner of APP.

- ◆ Click the avatar position to register.
- ◆ "Language" for language switching, supporting 3 languages.

Add device

Click "home" in the lower left corner of the app to switch to the add product module.

- ◆ Click "Add Device" or "+" to add products.

The "Message" is after-sales service.

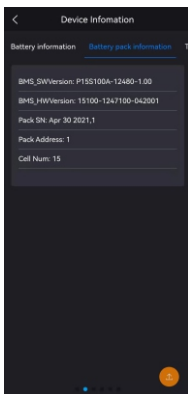
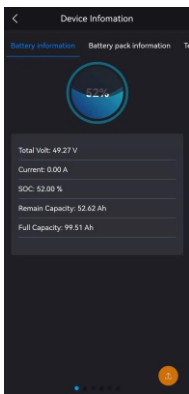

Click the connected battery to view the following information:

Battery information

- ◆ You can view the relevant information of battery voltage, working current and capacity.

Battery pack information

- ◆ You can view the number information of battery accessories.

Temperature

- ◆ You can view the temperature information of each part of the battery.

Voltage

- ◆ You can view the information about the cell voltage.

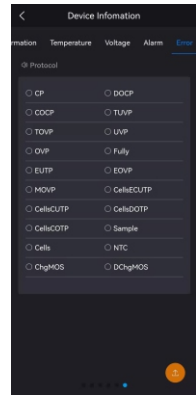
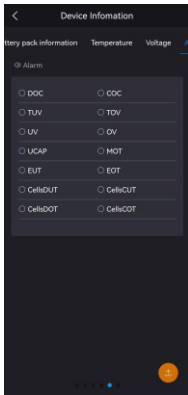

Alarm

◆ You can view battery alarm related information.

NO.	Items	Description	NO.	Items	Description
1	DOC	Discharge over current alarm	8	MOS OT	MOS High temperature alarm
2	COC	Charge over current alarm	9	EUT	Low environment temperature alarm
3	TUV	Total over discharge alarm	10	EOT	High environment temperature alarm
4	TOV	Total over charge alarm	11	DUT	Discharge low temperature alarm
5	UV	Cell over discharge alarm	12	CUT	Charge low temperature alarm
6	OV	Cell over discharge alarm	13	DOT	Discharge high temperature alarm
7	USOC	Low SOC alarm	14	COT	Charge high temperature alarm

Protection

◆ You can view information about battery protection.

NO.	Items	Description	NO.	Items	Description
1	CP	Short Circuit Protection	12	DUTP	Discharge low temperature protection
2	DOCP	Discharge over current protection	13	CUTP	Charge low temperature protection
3	COCP	Charge over current protection	14	DOTP	Discharge high temperature protection
4	TUVP	Total under voltage protection	15	COTP	Charge high temperature protection
5	TOVP	Total over voltage protection	16	PCB	PCB Protection
6	UVP	Cell over discharge protection	17	Sample	Sample Protection
7	OVP	Cell over voltage protection	18	Cells	Battery Cells Protection
8	Fully	Fully protection	19	NTC	NTC Protection
9	EUT	Low environment temperature protection	20	chg MOS	Charge MOS protection
10	EOT	High environment temperature protection	21	dhg MOS	Discharge MOS protection
11	MOS OT	MOS High temperature protection			

6. Battery monitoring

6.1 Software running environment

The software runs on PC and it is compatible to use Windows operating system. The system environment requires the support of Microsoft .Net Framework version 2.0 or above. Please confirm that it has been installed before use. The installation is as follows:



- ◆ Download Microsoft .Net framework
- ◆ Double click the downloaded program to install it
- ◆ This software does not need to be installed independently, but only needs to meet the environment. Double click the main program icon to run it.

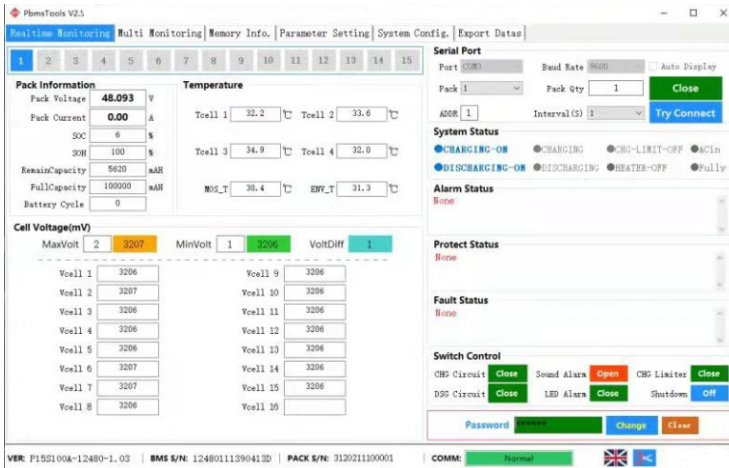

6.2 Connect the upper computer

- ◆ Ensure that the BMS board is normally powered on and not in sleep state, the crystal head of the communication line is inserted into the communication port of the protection board, and the USB end is inserted into the computer.
- ◆ Double click to start the upper computer.
- ◆ Click the "try to connect" button to search the serial port to try to connect. Or manually select the serial port and click the "open serial port" button link.

Explanation

If connection fails for the following reasons, the resolutions are:

- ◆ Using the wrong host computer:
Method: replace the correct version of the upper computer.

- ♦ Poor communication line or wrong wiring:
Method: replace the communication line or correct the wrong wiring.
- ♦ The computer USB interface is not recognized:
Method: change a USB interface
- ♦ Drive not installed:
Method: install the driver corresponding to the communication line.

Method for judging whether the communication line driver has been installed:

- ♦ Check whether there is a relevant COM port in the "serial port" drop-down of the upper computer. If it is not found, it may not be installed.
- ♦ Press the win key and R key at the same time to open the [run] window, enter the devmgmt.msc command, and open the [device manager].

6. 3 Interface function

6.3.1 Real time monitoring

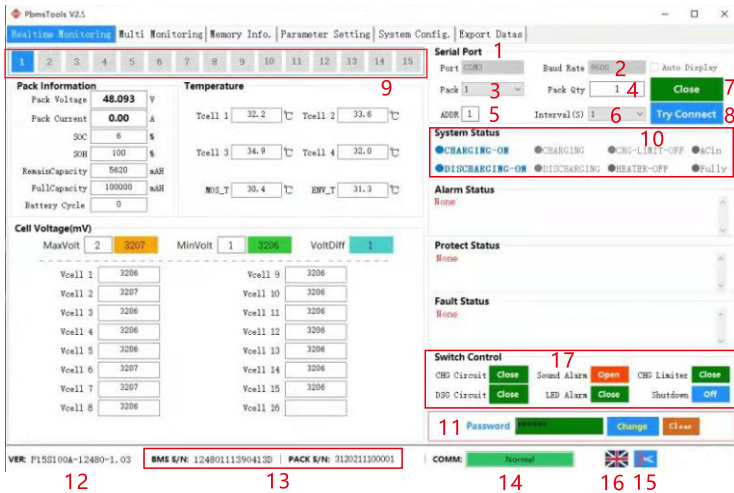

NO.	Item	Description
1	Serial port	Serial port: you can select the drop-down item to select the serial port to communicate. (Note: available when the serial port is not opened)
2	Baud rate	Baud rate: you can select the drop-down item to select the baud rate of communication. (Note: available when the serial port is not opened)
3	PACK	Pack: the drop-down item can be selected. When FF is selected, access the RS232 interface of the host to obtain all pack data. (Note: available when the serial port is not opened)
4	PACK QTY	Number of packs: the total number of packs read by the upper computer from the BMS board (when applied to multiple computers in parallel, the pack data is obtained from the main pack).
5	ADDR	Address: the currently read BMS address value.
6	Intervals	Interval (seconds): optional. The interval between the upper computer reading data from the BMS board.
7	Close	Turn on the serial port: turn on or off the serial port by alternating the function buttons.

NO.	Item	Description
8	Try connect	Try to connect: search for available serial ports and open them.
9	Pack serial number group	The data key, which is the package serial number, displays the package being read and presented on the current interface with white words on a blue background; "Auto" key, alternate function buttons. Available when FF is selected for pack in 3 and monitoring is started, i.e. each pack data is displayed automatically in cycle (when applied to multiple machines in parallel).
11	Administrator password column	Some setting functions can only be used after entering the administrator password. When the password is entered correctly, the input box will turn green. At this time, you have obtained the authority of the administrator.
12	Version	software version number of BMS.
13	S/N	Barcode and pack s / N of BMS board.
14	Monitor communication status	Communication status between upper computer and BMS board.
15	Screenshot function	Click to enter the screenshot status, and the toolbar will appear after marking out the screenshot area with the mouse.
16	Flag Icon	Displays the flag icon of the current language country. Click to switch languages.
17	Switch control	When the button is red, it indicates that the function processing is off, and when it is green, it indicates that it is on.

Explanation

- ♦ Try to connect:
First set the baud rate and pack on the upper computer, connect the BMS board with the RS232 communication line, then insert the USB interface of the RS232 communication line into the USB port of the computer, and then click the "try to connect" button to automatically search and open the effective serial port.
- ♦ Automatic rotation pack:
When FF is selected in the "pack" drop-down item, the "rotation" check box in the interface becomes available. Check it to use the rotation function. Uncheck it to cancel the rotation function.

Port Baud Rate Auto Display

Pack Pack Qty

- ♦ Change Password:
Click the "Change" button at the bottom right of the interface to pop up the password modification window. Enter the old password and the new password and then confirm. Note: there is no function to retrieve the password. Please remember the modified new password.

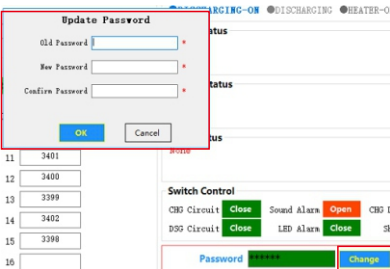

The screenshot shows a software interface with a dialog box titled "Update Password" in the foreground. The dialog box has three input fields: "Old Password", "New Password", and "Confirm Password", each with a red asterisk indicating a required field. Below the fields are "OK" and "Cancel" buttons. In the background, the "Switch Control" section is visible, featuring several status indicators (e.g., "CHG Circuit", "Sound Alarm", "LED Alarm") with "Close" and "Open" buttons. A "Change" button is highlighted in the "Password" section of the interface.

- ◆ Get administrator privileges:
Enter the administrator password in the "administrator password" input box at the bottom right of the interface. After correctly entering the password, the input box turns green. At this time, you have obtained administrator permission.



6.3.2 Parallel monitoring

- ◆ Interface:
Click the main interface tab [Multi Monitoring] to enter the interface.

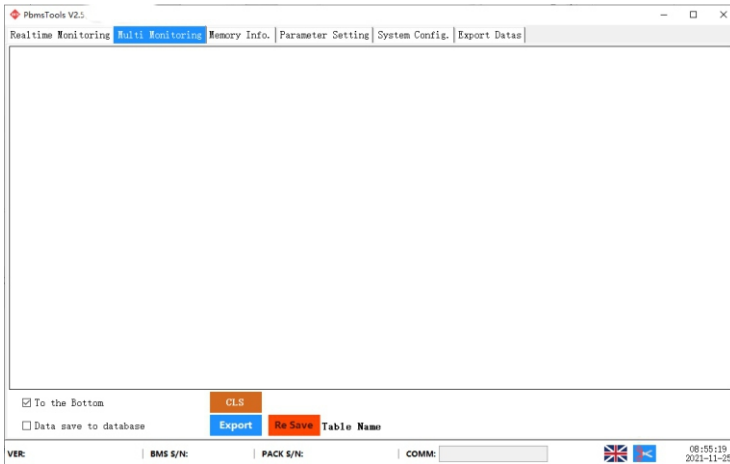

- ◆ To the Bottom:
Check "To the Bottom" at the bottom left to display the monitored real-time data in the data area. Note: this function only displays the data on the interface, and the data has not been saved.
- ◆ Clear interface data:
Click the button "CLS" to clear the real-time data on the interface.
- ◆ Record data
Check "Data save to database" to start recording data. When there is data recording, the number of saved data will appear on the right.
- ◆ Export data
Click the "Export " button to export the recorded real-time data. You can also export on the export data page.

6.3.3 Store information.

- ◆ Interface:
Click the main interface tab [Memory Info.] to enter the interface.
- ◆ Read / write BMS time:
Click the "Read BMS" button on the upper right to read the BMS time.
Click the "Write To BMS" button on the upper right to write the BMS time.
- ◆ Storage settings:
Range: start sequence number and maximum sequence number.
Read records: read stored records.

Pause / continue: when reading, click "pause" to read, and then click again to continue reading.

Save record: save the record on the interface to local.

Delete record: delete the storage record of BMS board.

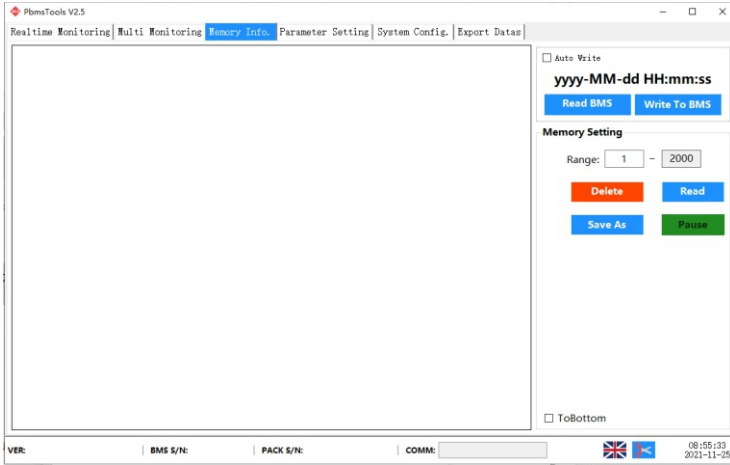

Explanation

when reading, the prompt "no more data" indicates that the reading has been completed.

6.3.4 Parameter setting

- ◆ Interface:

Click the main interface tab [Parameter Setting] to enter the interface.



- ◆ Function:

Read parameters: read all parameters in the interface.

Write parameters: overwrite BMS parameters. This operation requires administrator privileges.

Restore default parameters: restore all parameters to the default parameters. The default parameters are from the preset parameters in BMS. This operation requires administrator privileges.

Import parameters: read the data in the local file into this interface. Note: the data is only read on the interface and has not been written into the BMS. If you need to write, please execute the write operation.

6.3.5 System settings

◆ Interface:

Click the main interface tab [System Config.] to enter the interface.

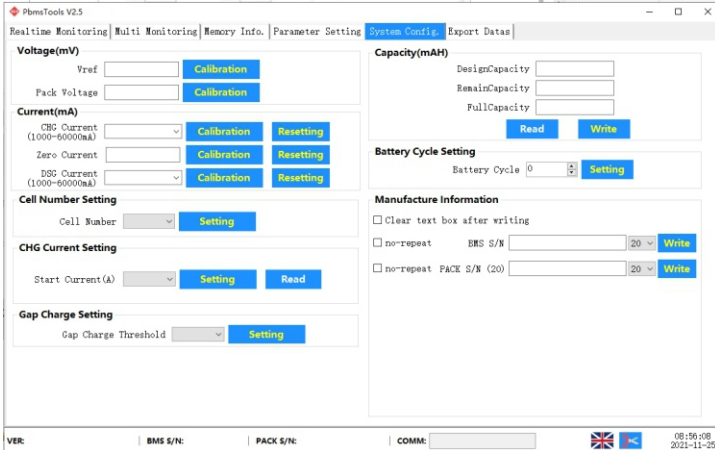

◆ function:

Just follow the interface prompts. Some function operations require administrator privileges.

6.3.6 Export data

After checking "record data" on the [parallel monitoring] page, the recorded data can be exported on this page. The table is named after the starting time point of the record. The data can be saved for up to two months, and the expired data will be automatically cleared. You can double-click the table name to export data.

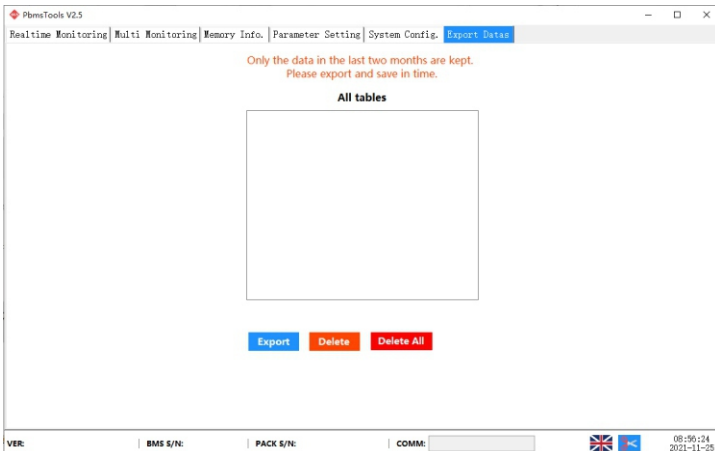

6.4 Replacing inverter protocol on battery monitoring(Optional)

Software running environment

This function can only be realized by installing the protocol conversion board. Before using this function, please confirm whether the protocol conversion board is installed on this battery.

This software does not need to be installed independently, but only needs to meet the environment. Double click the main program icon to run it.

- ◆ Connect the computer to the battery via the USB-RS485 communication cable.



- ◆ Setting for DID.



- ◆ Click to open the Inverter software on the PC.
- ◆ Select the right serial port.

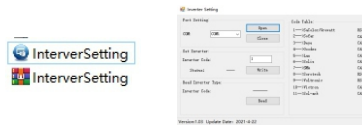

- ◆ Click the "Read" button to read the current inverter code.
- ◆ Click the "Write" button the inverter code that you need.
- ◆ Click the "Read" button to read the inverter code again, and confirm whether the operation was successful or not.
- ◆ Reference table of different inverter code.

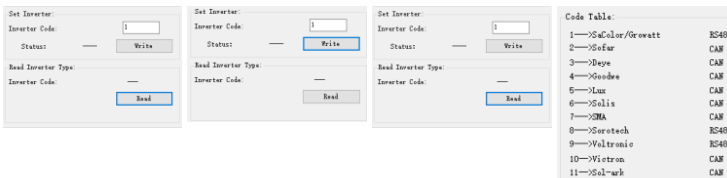

7. Maintenance and replacement

- ◆ Please maintain the equipment when you are familiar with and understand the contents of this manual and have appropriate tools and test devices.
- ◆ Before carrying out maintenance work, please power down the equipment first, then follow the instructions of the delayed discharge label and wait for the corresponding time to ensure that the equipment has been powered down before operating the equipment.
- ◆ During maintenance, please try to avoid irrelevant personnel entering the maintenance site, and temporary warning signs or fences must be erected for isolation.
- ◆ If the equipment fails, please contact your dealer in time.
- ◆ The equipment can be powered on again only after the fault is handled, otherwise it may cause fault expansion or equipment damage.
- ◆ Do not open the cover plate without authorization, otherwise there will be a risk of electric shock, and the resulting failure does not belong to the scope of warranty.
- ◆ Operation and maintenance personnel and professional technicians shall be fully trained in safe use and equipment maintenance, and shall operate with sufficient preventive measures and personal protective equipment.
- ◆ Battery maintenance shall be performed or supervised by personnel familiar with the battery and its required precautions.
- ◆ After the maintenance operation, check immediately to ensure that no tools or other parts are missing in the equipment.

8. Battery storage requirements

- ◆ When the battery is stored, it shall be placed correctly according to the identification of the packing box, and shall not be placed upside down or on the side.
- ◆ When the battery packing box is stacked, it shall meet the stacking requirements on the outer package.
- ◆ The battery shall be handled with care, and it is strictly prohibited to damage the battery.
- ◆ Storage environment requirements:
 - a. Ambient temperature: $-10\text{ }^{\circ}\text{C} \sim 55\text{ }^{\circ}\text{C}$, recommended storage temperature: $20\text{ }^{\circ}\text{C} \sim 30\text{ }^{\circ}\text{C}$.
 - b. Relative humidity: 35% RH ~ 85% RH.
 - c. Dry, ventilated and clean.
 - d. Avoid contact with corrosive organic solvents, gases and other substances.
 - e. Avoid direct sunlight.
 - f. The distance from the heat source shall not be less than two meters.
- ◆ When the battery is stored, it must be disconnected from the outside. If there is an indicator on the battery panel, the indicator should be off.
- ◆ The warehouse keeper shall count the battery storage every month and regularly report the battery inventory to the planning link. For batteries with storage time close to $-20 \sim 25\text{ }^{\circ}\text{C} = 6$ months and $-20 \sim 45\text{ }^{\circ}\text{C} = 1$ month, replenishment shall be arranged in time. The battery shall be charged once every three months (under the normal storage environment, long-term storage will lead to capacity attenuation and cycle life decline. If it exceeds the storage environment requirements, it will further aggravate the capacity attenuation and cycle life decline.)
- ◆ When the stored batteries are shipped, the principle of first in first out shall be followed.
- ◆ Battery maintenance shall be performed or supervised by personnel familiar with the battery and its required precautions.
- ◆ After the battery production test is completed, it needs to be supplemented to 30-50% SOC at least before storage.

9.Compatible List of 7.6KWh POWER ESS and Inverters

48V/51.2V Energy Storage System Solution										Compatible List of 7.6KWh POWER ESS and Inverters			Ver:1.02 Last update: 20/09/2024	
Item	Manufacturer	Inverter Type	Communication	Application	Key Features		Installation	Amend						
					Activation	Force Charge		Done	Testing					
1	Sacolor	5KW, 10KW, 12KW SPF 3500ES, SPF5000ES	RS485	Off Grid	Yes	Yes	Wall mounting	√						
2	Growatt	SPH-3000TL-US, SPH-3600TL-US, SPH-4000TL-US, SPH-4800TL-US, SPH-5000TL-US, SPH-6000TL-US	CAN	Hybrid grid	Yes	Yes	Wall mounting	√						
3	Sofar	HYD-3000-EP, HYD-3680-EP, HYD-4000-EP, HYD-4600-EP, HYD-5000-EP, HYD-5500-EP, HYD-6000-EP	CAN	Hybrid grid	Yes	Yes	Wall mounting	√						
4	Lux power	LXP-4K HB, LXP -5K HB , LXP-6K HB	CAN	Hybrid grid	Yes	Yes	Wall mounting	√						
5	Goodwe	ES/EM/5-BP/BP Series	CAN	Hybrid grid	Yes	Yes	Wall mounting	√						
6	Deye	SUN-3, 6-5K-SC03LP1-EU/SUN-5-8K-SC01LP1-US Series	CAN	Hybrid grid	Yes	Yes	Wall mounting	√						
7	Solis	RH1-3-6/K, 48ES, \SS-EH1 R3-6/K-L Series	CAN	Hybrid grid	Yes	Yes	Wall mounting	√						
8	Sorotech	REVO-II 3-5K Series	CAN	Hybrid grid	Yes	Yes	Wall mounting	√						
9	SMA	SUNNY ISLAND 3.0M / 4.4M / 6.0H / 8.0H	CAN	Off Grid	Yes	Yes	Wall mounting	√						
10	Victron	MultiPlus-II-CX 3KVA-5KVA-8KVA-15KVA	CAN	Off Grid	Yes	Yes	Wall mounting	√						
11	Sol-ark	Sol-ark 10KW/12KW	CAN	Hybrid grid	Yes	Yes	Wall mounting	√						
12	Megarevo	R3K-6K/L1, R3K-12K/H1NA	CAN	Hybrid grid	Yes	Yes	Wall mounting	√						
13	Voltronic	3KW~12KW SERIES	RS485	Off Grid	Yes	Yes	Wall mounting	√						
14	Afore	AF1K-SL-1 AF1.5K-SL-1 AF2K-SL-1 AF2.5K-SL-1 AF3K-SL-1 AF3.6K-SL-1 AF3K-SL AF3.6K-SL AF4K-SL AF4.6K-SL AF5K-SL AF5.6K-SL AFBK-SL	CAN	Hybrid grid	Yes	Yes	Wall mounting	√						
15	Isuna	Isuna 5.12-100-LF Isuna 5.12-100-LF Isuna 5.12-100-LF Isuna 5.12-100-LF Isuna 5.12-100-LF Isuna 5.12-100-LF	CAN	Hybrid grid	Yes	Yes	Wall mounting	√						

Note: Compatible tests with different brands of inverter are continuously, updates of this list will be periodically.